

CSS



Kleines Kunststoffgehäuse mit Silikonhülle.

Small plastic case with silicone cover.

Mit Batteriefach für Knopfatterie CR2032.
Drei Größen und 12 Farbkombinationen.

Built-in CR2032 coin battery compartment.
Selectable in 3 sizes & 12 color combinations.

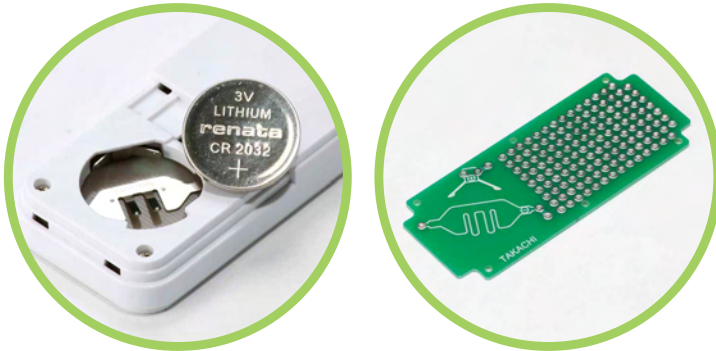

pink
pink

gelb
yellow

schwarz
black

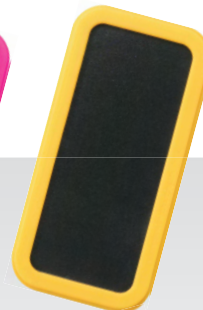

grün
green

cyan
cyan

lichtgrau
light gray



6 Colors



- Individuelle Bearbeitung mittels Fräsen, Siebdruck, Aufkleberdruck etc. nach Ihren Vorgaben.
- We take care of your customization by milling, silk-screening, sticker printing and so on.

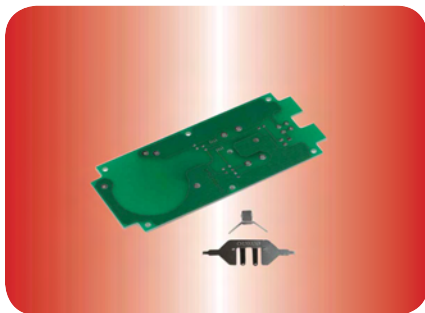

Verlöten der Kontakte auf der Platine.

Soldering a contact on PCB.

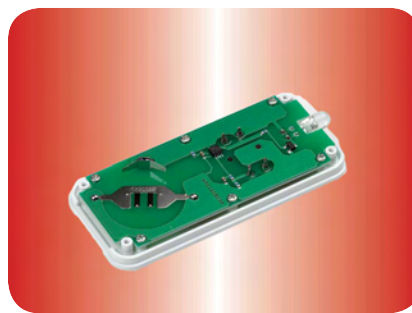

Einbau der Platine auf der oberen Abdeckung

Installing PCB on top cover.



Alles Montiert!

All is assembled!



Batterien sind einfach zu wechseln. Einfach Batteriedeckel aufschieben.

Easy to change the battery; only open compartment with sliding cover.



Mit einer Öse, um ein Band zu befestigen. Die Silikonhüllen können beliebig oft an- und abgezogen werden.

Strap hole is ready. Able to slip on & off a silicone cover to a box with a strap attached.

Kleines Kunststoffgehäuse mit Silikonhülle

Small plastic case with silicone cover









- Kleines Kunststoff-Gehäuse mit Silikonhülle,
- Elastisch und rutschhemmend,
- Optional mit Batteriefach für Knopfatterie CR2032,
- Geeignet für Fernbedienungen, Wireless Schlüsselanhänger, kleine Tester oder andere Anwendungen,
- Verfügbar in drei Größen und 12 Farbkombinationen,
- Silikonhüllen in zwei Ausführungen mit und ohne einer rechteckige Öffnung auf der kurzen Seite,
- Befestigungsmöglichkeit einer Trageschleufe,
- Small plastic case with silicone cover,
- Flexible and grippy,
- Built-in CR2032 battery compartment for an easy to change coin battery,
- Suitable for remote controllers, wireless key fob, small tester/devices and other applications,
- Available in 3 case sizes and selectable in 12 color combinations,
- 2 types of the silicone cover available with (open) and without (closed) a rectangle hole on one short side,
- Mounting option for use with a strap.

Einzelteile Components

Ref.-Nr. Ref. no.	Bezeichnung Part name	Stück Pcs	Material Material	Farbe / Oberfläche Color / Finish
1	Deckel Top cover	1	ABS (UL94HB)	weiß / schwarz white / black
2	Boden Bottom cover	1	ABS (UL94HB)	weiß / schwarz white / black
3	Batteriedeckel Battery cover	1	ABS (UL94HB)	weiß / schwarz white / black
4	Batteriekontakt Battery contact	1 Satz 1 Set	SUS304	vernickelt nickel plated
5	Silikonhülle Silicone cover	1	Silikon Silicone	pink / gelb / grün / cyan / lichtgrau / schwarz pink / yellow / green / cyan / light gray / black
6	Schraube Screw	4	M1,6 Stahl M1.6 Steel	vernickelt schwarz ver- chromt nickel plated black triva- lent chromate
7	CR2032 Aufkleber CR2032 sticker	1	PP	-

Hülle Shape		
Code	Geschlossen / closed CL	Offen / open OP

Farbe color

Farbe Color						
Farbcode Color code	schwarz / pink black / pink BP	schwarz / gelb black / yellow BY	schwarz / grün black / green BG	schwarz / cyan Blau black / cyan blue BC	schwarz / lichtgrau black / light gray BL	schwarz / schwarz black / black BB
Farbe Color						
Farbcode Color code	weiß / pink white / pink WP	weiß / gelb white / yellow WY	weiß / grün white / green WG	weiß / cyan white / cyan blue WC	weiß / lichtgrau white / light gray WL	weiß / schwarz white / black WB

CSS Maße CSS dimensions

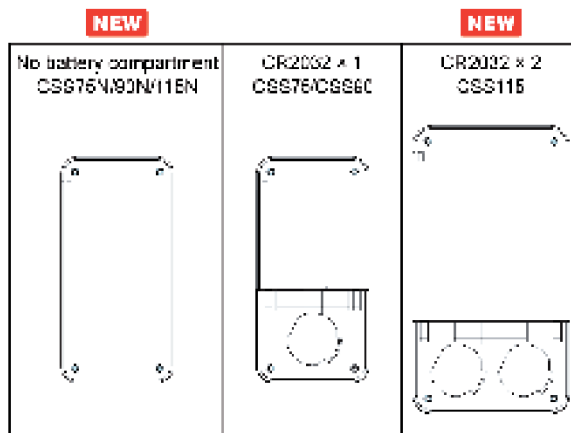
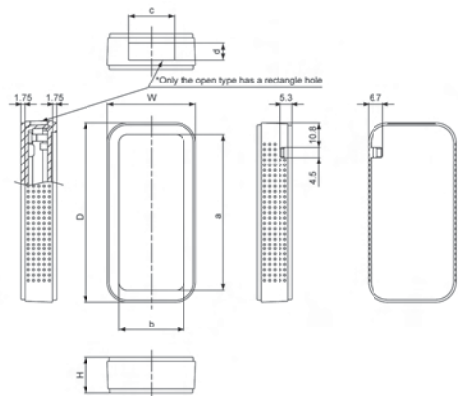

Bitte vervollständigen Sie die Bestellnummer am Ende mit dem Farbcode.

Please suffix color code at the end of the part number

Best.-Nr. Part no.	W	H	D	a	b	c	d	e	Batteriefach Battery compartment	Gewicht (g) Weight (g)
CSS75NCL□□	38,6 (35)	15,5 (12)	78,6 (75)	68,4	28,4	-	-	1.75	None / ohne	24
CSS75NOP□□	38,6(35)	15,5 (12)	78,6 (75)	68,4	28,4	20	7,4	1.75	None / ohne	24
CSS75CL□□	38,6 (35)	15,5 (12)	78,6 (75)	68,4	28,4	-	-	1.75	CR2032x1	25
CSS75OP□□	38,6(35)	15,5 (12)	78,6 (75)	68,4	28,4	20	7,4	1.75	CR2032x1	25
CSS90NCL□□	48,6 (45)	15,5 (12)	93,6 (90)	82,4	37,4	-	-	1.75	None / ohne	36
CSS90NOP□□	48,6(45)	15,5 (12)	93,6 (90)	82,4	37,4	30	7,4	1.75	None / ohne	35
CSS90CL□□	48,6 (45)	15,5 (12)	93,6 (90)	82,4	37,4	-	-	1.75	CR2032x1	38
CSS90OP□□	48,6(45)	15,5 (12)	93,6 (90)	82,4	37,4	30	7,4	1.75	CR2032x1	37
CSS115NCL□□	67.1(63)	16(12)	119.1(115)	107.4	55.4	-	-	2	none / ohne	62
CSS115NOP□□	67.1(63)	16(12)	119.1(115)	107.4	55.4	45	7.4	2	none / ohne	61
CSS115CL□□	67.1(63)	16(12)	119.1(115)	107.4	55.4	-	-	2	CR2032x2	65
CSS115OP□□	67.1(63)	16(12)	119.1(115)	107.4	55.4	45	7.4	2	CR2032x2	64

Kleines Kunststoffgehäuse mit CR2032 Batteriefach
Small plastic case with built-in CR2032 battery compartment

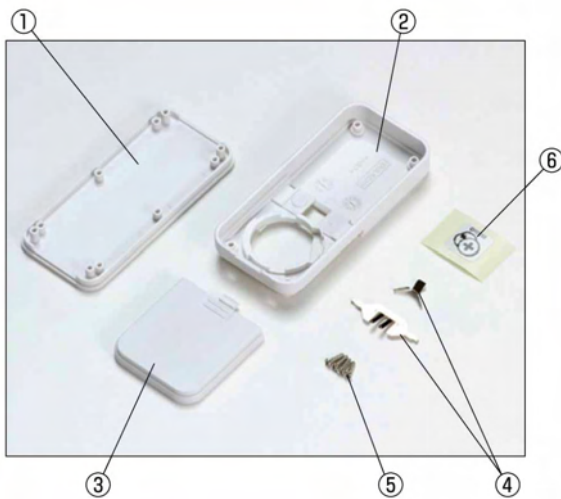

Eigenschaften Features

- Kleines Kunststoffgehäuse mit CR2032 Batteriefach.
- Geeignet für Fernbedienungen, Wireless Schlüsselanhänger, kleine Tester oder Geräte.
- Möglichkeit zur Befestigung einer Trageschleufe.
- Small plastic case with built-in CR2032 battery compartment.
- Suitable for a remote controller, wireless key fob, small tester/device and other applications.
- A hole on one side of the case is provided for use with a wear loop as optional part.

Einzelteile Components

Ref.-Nr. Ref. no.	Bezeichnung Part name	Stück Pcs	Material Material	Farbe / Oberfläche Color / Finish
1	Deckel top cover	1	ABS (UL94HB)	weiß / schwarz white / black
2	Boden bottom cover	1	ABS (UL94HB)	weiß / schwarz white / black
3	Batteriedeckel battery cover	1	ABS (UL94HB)	weiß / schwarz white / black
4	Batteriekontakt battery contact	1 Satz / 2er Satz (CS115) 1 set / 2 set (CS115)	Edelstahl Stainless steel	vernickelt nickel plated
5	selbstschneidende Schraube self tapping screw	4	M1.6 Stahl M1.6 steel	vernickelt / schwarz verchromt nickel plated / black trivalent chromate
6	CR2032 Aufkleber CR2032 sticker	1	PP	-

Bestellnummer / Part no.

Bestellnummer Part no.	W	H	D	a	b	Batteriefach Battery compartment	Gewicht Weight (g)
CS75N	35	12	75	28.4	68.4	None	12
CS75	35	12	75	28.4	68.4	CR2032 × 1	13
CS90N	45	12	90	37.4	82.4	None	18
CS90	45	12	90	37.4	82.4	CR2032 × 1	20
CS115N	63	12	115	55.4	107.4	None	30
CS115	63	12	115	55.4	107.4	CR2032 × 2	33

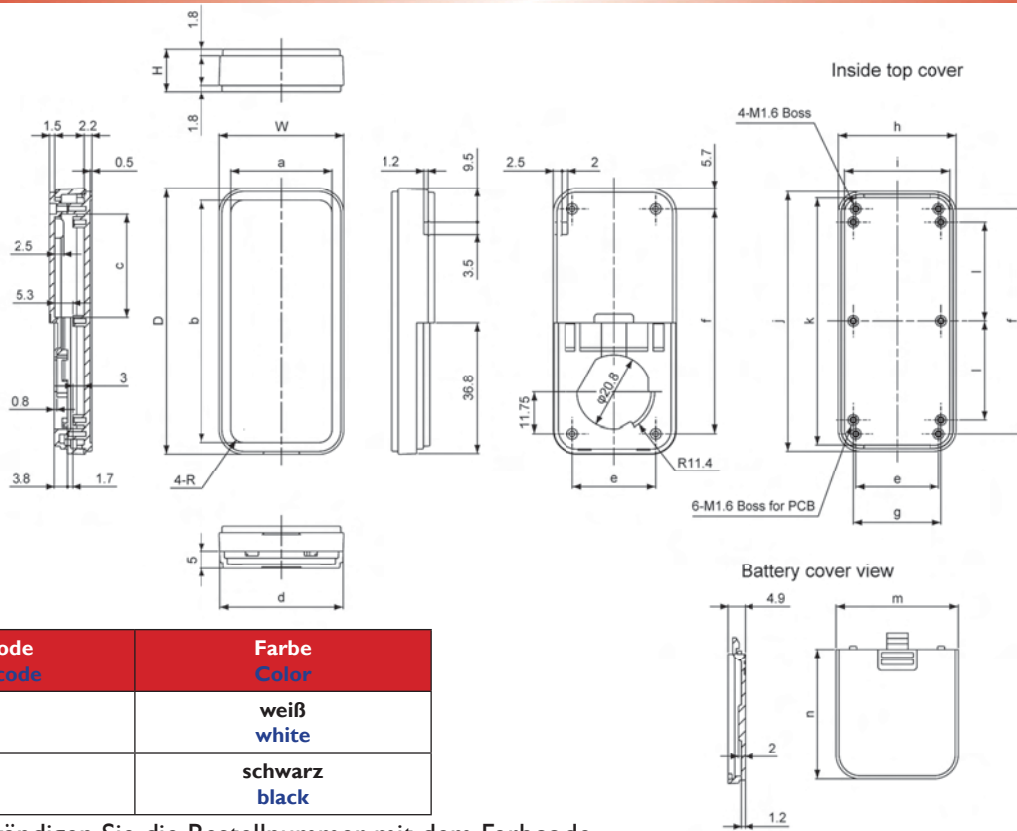

Farbcode Color code	Farbe Color
W	weiß white
B	schwarz black

Bitte vervollständigen Sie die Bestellnummer mit dem Farbcode
Please suffix color code at the end of the part number

Best.-Nr. Part no.	W	H	D	R	a	b	c	d	e	f	g	h	i	j	k	l	m	n	Gewicht Weight (g)
CS75□	35	12	75	3,7	28,4	68,4	29,3	34,6	23,5	63,5	24,9	33,4	29,9	73,4	69,8	28	34,6	36,8	13
CS90□	45	12	90	3.2	37.4	82.4	44.3	44.6	33.5	78.5	34.9	43.4	39.9	88.4	84.8	35.5	44.6	36.7	20
CS115□	63	12	111	54.7	55.4	107.4	10.5	61.4	113.4	57.9	109.8	52.9	50.5	102.5	47.5	58	110	9.5	30

Max. Leiterplattengröße und Position für die Montage der Batteriekontakte
Maximum PCB size & battery contacts mounting position

Achtung:

Achten Sie auf die korrekte Montageposition der Batteriekontakte.

Note:

Be aware of the correct position of the battery contacts.

CS75

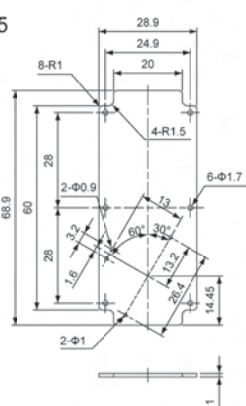

CS90

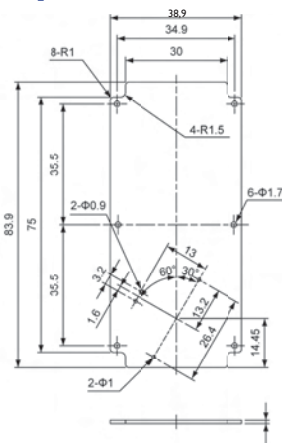

Montierte Kontakte
mounted contacts

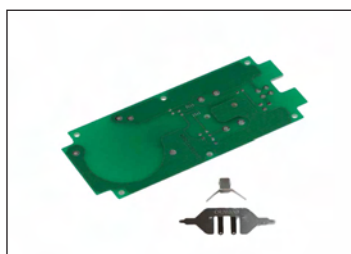

CR2032-Batteriefach
CR2032-battery compartment

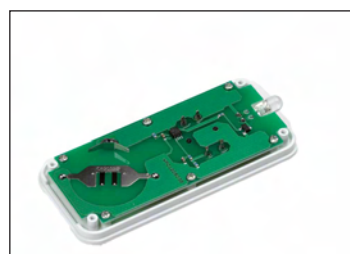

Richtig
right

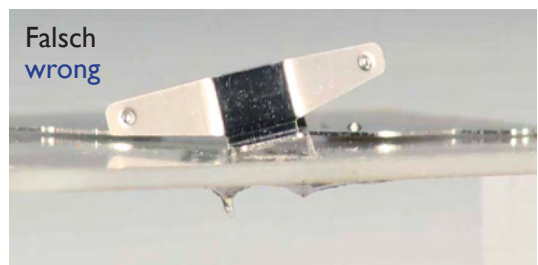

Falsch
wrong

CSSC Silikonhüllen

CSSC silicone cover

Hülle Shape		
Code	Geschlossen / closed CL	Offen / open OP

- 2 Arten von Silikonhüllen sind verfügbar: mit und ohne rechteckiger Öffnung an der Vorderseite
- In 6 Farben
- Sonderfarben ab 1000 Stück
- Prepared 2 types of the silicone covers which are with (open) and without (closed) a rectangle hole on the front side.
- Selectable in 6 colors.
- Custom colors available > 1000 pcs.

Farben Colors

Farbe Color						
Farb- code Color code	pink Pink P	gelb Yellow Y	grün Green G	cyan Cyan C	lichtgrau Light gray L	schwarz Black B

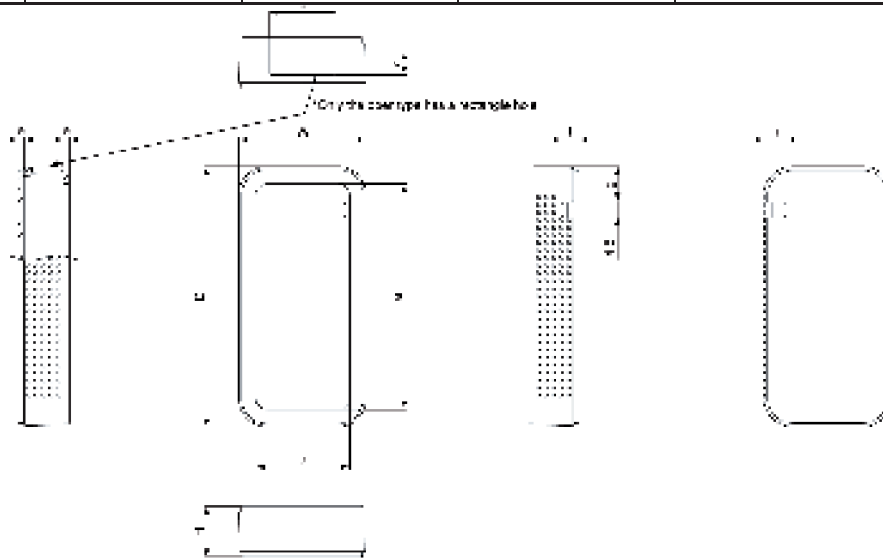

Einzelteile Components

Bezeichnung Part name	Stück Pcs	Material Material	Farbe Color / Finish
Silikonhülle Silicone cover	1	Silikon Silicone	pink / gelb / grün / blau / lichtgrau / schwarz pink / yellow / green / blue / light gray / black

Bestellnummer

Bitte vervollständigen Sie die Bestellnummer mit dem Farbcode

Part no. dimensions

Please suffix color code at the end of part number

Best.-Nr. Part no.	W	H	D	a	b	c	d	e	f	g	h	Geeignetes Gehäuse suitable case	Gewicht Weigh (g)
CSSC75CL□	38,6	15,5	78,6	68,4	28,4	-	-	1.75	5.25	10.8	6.7	CS75	12
CSSC75OP□	38,6	15,5	78,6	68,4	28,4	20	7,4	1.75	5.25	10.8	6.7	CS75	12
CSSC90CL□	48,6	15,5	93,6	82,4	37,4	-	-	1.75	5.25	10.8	6.7	CS90	18
CSSC90OP□	48,6	15,5	93,6	82,4	37,4	30	7,4	1.75	5.25	10.8	6.7	CS90	17
CSSC115CL□	67.1	16	119.1	107.4	55.4	-	-	2	5.5	12.1	7	CS115	32
CSSC115OP□	67.1	16	119.1	107.4	55.4	45	7.4	2	5.5	12.1	7	CS115	31